

DC-DC MIL-COTS

PRODUCT # SW2511006-22-01

12–36 VDC
Input Voltage

22 VDC
Output Voltage

840 W
Output Power

1
of Outputs



Actual product appearance may vary.

PRODUCT DESCRIPTION

This DC-DC power supply is designed to perform and protect in harsh, military environments. It is environmentally sealed to meet IP67 when mated with connectors and cable assemblies. It is compact in size, weighing approximately 8.1 lb, and is convection cooled. It is designed to meet the input power requirements of MIL-STD-1275E. This power supply was designed and built with quality assurance. Custom output voltages are available—contact ACT for more information.

ENVIRONMENT

Designed to meet MIL-STD-810



TEMPERATURE

-40°C to +71°C operating, -40°C to +85°C non-operating



HUMIDITY

Up to 100% condensing with sealed mating connectors and cable assemblies attached



VIBRATION

Designed to meet NAVMAT P-9492



SHOCK

Designed to meet MIL-STD-202, Method 213, Test Condition J



EMI

Designed to meet MIL-STD-461G, CE102

FEATURES

- Single output of 22 V up to 840 W
- 12–36 VDC input
- Designed to meet MIL-STD-1275E
- Efficiency up to 96%
- Output current maximum of 38.2 A
- Ripple \leq 240 mVp-p
- Regulation 5%, line and load
- Non-isolated
- *See derating details on page 3*

CONTACT US



2001 Fulling Mill Road | Middletown, PA 17057
717.939.2300 | CAGE: 60642

ACTPower.com | 

DC-DC MIL-COTS

PRODUCT # SW2511006-22-01

MECHANICAL INFORMATION

- 10.05" (L) x 7.24" (W) x 2.20" (H) Max
- Approx. 8.1 lb
- Clear Iridite, Chemically filmed in accordance with MIL-DTL-5541, Type 2, Class 1A
- Environmentally sealed to meet IP67 when mated with connectors and cable assemblies
- Alternative connector finishes may be available—contact us to learn more

CONNECTORS

J1 Input: D38999/20WE6PN	
PIN	DESCRIPTION
A	+ V _{IN}
B	+ V _{IN}
C	+ V _{IN}
D	- V _{IN}
E	- V _{IN}
F	- V _{IN}
Suggested Mate: D38999/26WE6SN	

J2 Output: D38999/20WE6SN	
PIN	DESCRIPTION
A	+ V _{OUT}
B	+ V _{OUT}
C	OPEN
D	- V _{OUT}
E	- V _{OUT}
F	OPEN
Suggested Mate: D38999/26WE6PN	

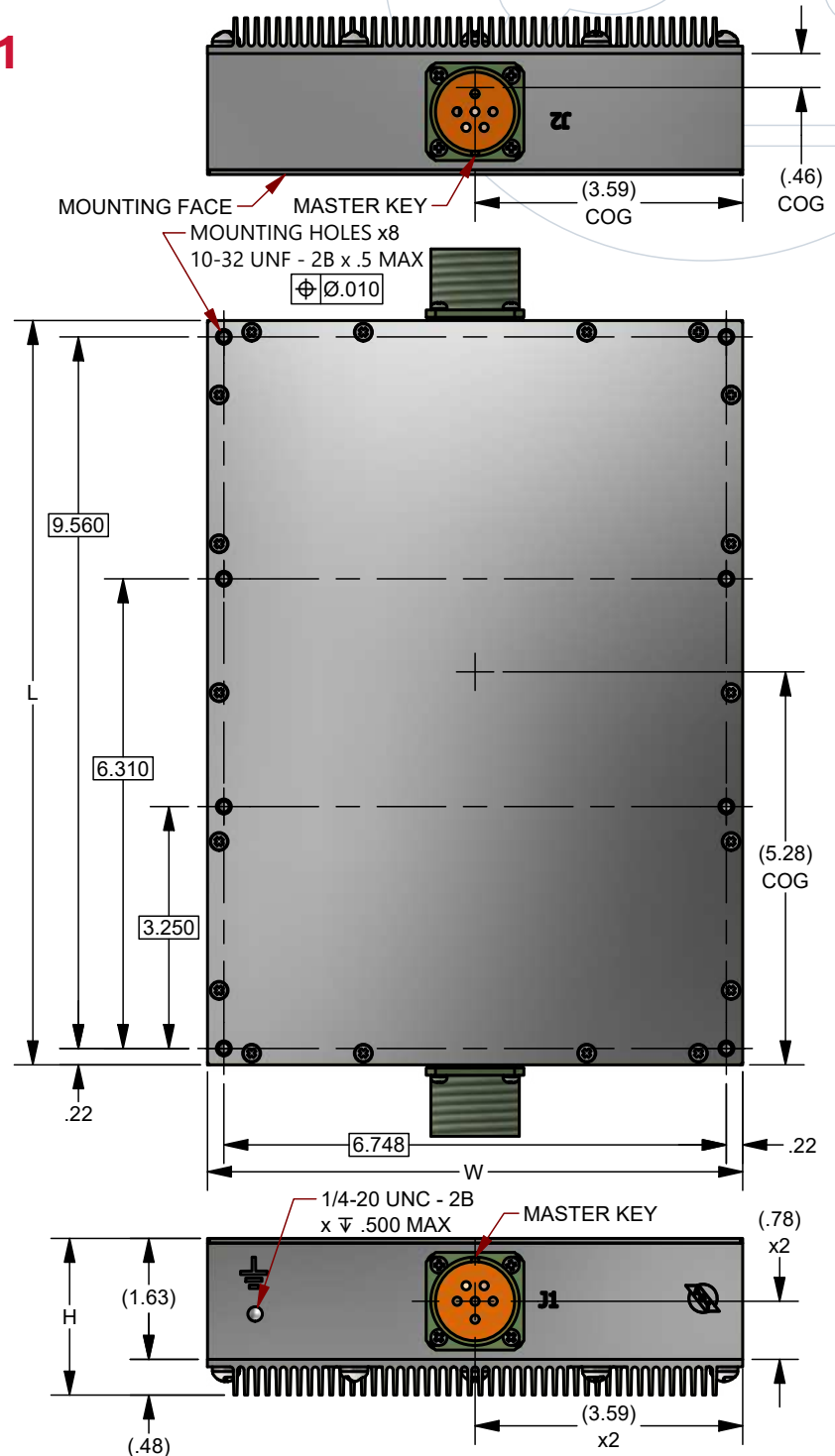

CONTACT US



2001 Fulling Mill Road | Middletown, PA 17057
717.939.2300 | CAGE: 60642

ACTPower.com | 

DC-DC MIL-COTS

PRODUCT # SW2511006-22-01

VOLTAGE & OUTPUT POWER DERATING

840 W output power can be achieved for 1 second with 12 VDC input voltage and 30 seconds with 16 VDC input voltage

V _{IN} (VDC)	V _{OUT} (VDC)	MAX OUTPUT POWER (W)
12 to 15	22	475
16 to 19	22	725
20 to 36	22	840

DERATING

NOTES

- Output performance is derated linearly from 0% at 50°C to 27% at 71°C

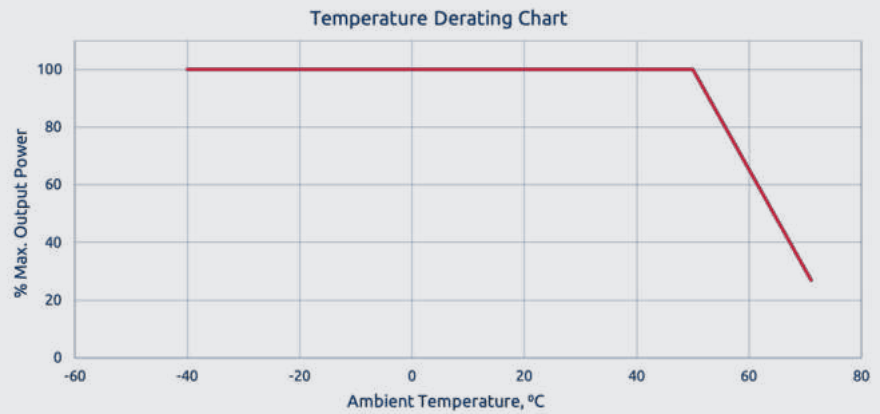

COOLING

Natural convection cooled. See “Derating Chart” above for additional information.

ISOLATION & PROTECTIONS

ISOLATION

- Non-isolated input/output
- Isolated input/chassis and output/chassis

PROTECTION

Reverse polarity, overtemperature, short circuit, and overvoltage with auto recovery

CONTACT US



2001 Fulling Mill Road | Middletown, PA 17057
717.939.2300 | CAGE: 60642

ACTPower.com | 

DC-DC MIL-COTS

PRODUCT # SW2511006-22-01



MAKE IT A MOTS

The right power solution helps keep equipment functioning properly in the field. MOTS, or Modified Off-The-Shelf, power supplies are adapted, ruggedized, and designed to meet the unique demands of your application.

The fast, budget-friendly answer for meeting your environmental requirements —ask us about making this power supply a MOTS.

SW2511006 SERIES SELECTOR GUIDE

ACT Product #	V _{IN} (VDC)	# of Outputs	V _{OUT} (VDC)	Output Power (W)	Heatsink
SW2511006-12	12 to 36	1	12	480	N
SW2511006-12-01	12 to 36	1	12	480	Y
SW2511006-15	12 to 36	1	15	600	N
SW2511006-15-01	12 to 36	1	15	510	Y
SW2511006-16	12 to 36	1	16	640	N
SW2511006-16-01	12 to 36	1	16	510	Y
SW2511006-18	12 to 36	1	18	720	N
SW2511006-18-01	12 to 36	1	18	715	Y
SW2511006-22	12 to 36	1	22	880	N
SW2511006-22-01	12 to 36	1	22	840	Y
SW2511006-24	12 to 36	1	24	960	N
SW2511006-24-01	12 to 36	1	24	1000	Y
SW2511006-26	12 to 36	1	26	1000	N
SW2511006-26-01	12 to 36	1	26	1000	Y
SW2511006-28	12 to 36	1	28	1000	N
SW2511006-28-01	12 to 36	1	28	1000	Y
SW2511006-32	12 to 36	1	32	1000	N
SW2511006-32-01	12 to 36	1	32	1000	Y

CONTACT US



2001 Fulling Mill Road | Middletown, PA 17057
717.939.2300 | CAGE: 60642

ACTPower.com | 